

COMPACT DISC PLAYER

CDJ-100S



Thank you for purchasing the Pioneer CDJ-100S Compact Disc Player. Be sure to read these operating instructions before using your player to prevent any damage that may result from improper operation. Once you have finished reading the instructions, place them in a safe place where they won't become lost and can be easily accessed for future reference.

WARNING: TO PREVENT FIRE OR SHOCK HAZARD, DO NOT EXPOSE THIS APPLIANCE TO RAIN OR MOISTURE.

IMPORTANT NOTICE

The serial number for this equipment is located on the rear panel. Please write this serial number on your enclosed warranty card and keep it in a secure area. This is for your security.

[For Canadian model]

CAUTION: TO PREVENT ELECTRIC SHOCK DO NOT USE THIS (POLARIZED) PLUG WITH AN EXTENSION CORD, RECEPTACLE OR OTHER OUTLET UNLESS THE BLADES CAN BE FULLY INSERTED TO PREVENT BLADE EXPOSURE.

ATTENTION: POUR PREVENIR LES CHOCS ELECTRIQUES NE PAS UTILISER CETTE FICHE POLARISEE AVEC UN PROLONGATEUR, UNE PRISE DE COURANT OU UNE AUTRE SORTIE DE COURANT, SAUF SI LES LAMES PEUVENT ETRE INSEREES A FOND SANS EN LAISSER AUCUNE PARTIE A DECOUVERT.

CONTENTS

CAUTIONS REGARDING HANDLING	3
FEATURES	4
CONNECTIONS	5
PANEL FACILITIES	7
Top Panel	7
Display Window	8
DISC LOADING/UNLOADING	8
ORDINARY CD PLAYER OPERATIONS	9
Setting the Auto Cue Function ON/OFF	9
Playback Operations	9
To Stop Play	9
To Pause Play	9
Track Cueing	9
Fast-Forward/Fast-Reverse	9
DJ PLAYER OPERATION	10
Playback Operations with Auto Cue Function ON	10
Cueing by Frames	10
Setting a Cue Point	10
SPECIAL DISC JOCKEY TECHNIQUES	11
Jog Dial Functions	11
Master Tempo	11
Using Digital Jog Break	11
Cueing	12
Fader Start Playback	12
Relay Play Using Two Players	12
MIXING DIFFERENT TRACKS	13
DIGITAL MODE	14
TROUBLESHOOTING	14
SPECIFICATIONS	Back cover

CAUTION: This product satisfies FCC regulations when shielded cables and connectors are used to connect the unit to other equipment. To prevent electromagnetic interference with electric appliances such as radios and televisions, use shielded cables and connectors for connections.

[For Canadian model]

This Class B digital apparatus meets all requirements of the Canadian Interference-Causing Equipment Regulations.

[Pour le modèle Canadien]

Cet appareil numérique de la Classe B respecte toutes les exigences du Règlement sur le matériel brouilleur du Canada.

Information to User

Alteration or modifications carried out without appropriate authorization may invalidate the user's right to operate the equipment.

This equipment has been tested and found to comply with the limits for a Class B digital device, pursuant to Part 15 of the FCC Rules. These limits are designed to provide reasonable protection against harmful interference in a residential installation. This equipment generates, uses, and can radiate radio frequency energy and, if not installed and used in accordance with the instructions, may cause harmful interference to radio communications. However, there is no guarantee that interference will not occur in a particular installation. If this equipment does cause harmful interference to radio or television reception, which can be determined by turning the equipment off and on, the user is encouraged to try to correct the interference by one or more of the following measures:

- Reorient or relocate the receiving antenna.
- Increase the separation between the equipment and receiver.
- Connect the equipment into an outlet on a circuit different from that to which the receiver is connected.
- Consult the dealer or an experienced radio/TV technician for help.

IMPORTANT 1



The lightning flash with arrowhead symbol, within an equilateral triangle, is intended to alert the user to the presence of uninsulated "dangerous voltage" within the product's enclosure that may be of sufficient magnitude to constitute a risk of electric shock to persons.



CAUTION:
TO PREVENT THE RISK OF ELECTRIC SHOCK, DO NOT REMOVE COVER (OR BACK). NO USER-SERVICEABLE PARTS INSIDE. REFER SERVICING TO QUALIFIED SERVICE PERSONNEL.



The exclamation point within an equilateral triangle is intended to alert the user to the presence of important operating and maintenance (servicing) instructions in the literature accompanying the appliance.

NOTE: THE USER-SERVICEABLE PARTS COMPARTMENT WARNING IS LOCATED ON THE APPLIANCE BOTTOM.

IMPORTANT SAFETY INSTRUCTIONS

READ INSTRUCTIONS — All the safety and operating instructions should be read before the product is operated.

RETAIN INSTRUCTIONS — The safety and operating instructions should be retained for future reference.

HEED WARNINGS — All warnings on the product and in the operating instructions should be adhered to.

FOLLOW INSTRUCTIONS — All operating and use instructions should be followed.

CLEANING — The product should be cleaned only with a polishing cloth or a soft dry cloth. Never clean with furniture wax, benzene, insecticides or other volatile liquids since they may corrode the cabinet.

ATTACHMENTS — Do not use attachments not recommended by the product manufacturer as they may cause hazards.

WATER AND MOISTURE — Do not use this product near water — for example, near a bathtub, wash bowl, kitchen sink, or laundry tub; in a wet basement; or near a swimming pool; and the like.

ACCESSORIES — Do not place this product on an unstable cart, stand, tripod, bracket, or table. The product may fall, causing serious injury to a child or adult, and serious damage to the product. Use only with a cart, stand, tripod, bracket, or table recommended by the manufacturer, or sold with the product. Any mounting of the product should follow the manufacturer's instructions, and should use a mounting accessory recommended by the manufacturer.

CART — A product and cart combination should be moved with care. Quick stops, excessive force, and uneven surfaces may cause the product and cart combination to overturn.



VENTILATION — Slots and openings in the cabinet are provided for ventilation and to ensure reliable operation of the product and to protect it from overheating, and these openings must not be blocked or covered. The openings should never be blocked by placing the product on a bed, sofa, rug, or other similar surface. This product should not be placed in a built-in installation such as a bookcase or rack unless proper ventilation is provided or the manufacturer's instructions have been adhered to.

POWER SOURCES — This product should be operated only from the type of power source indicated on the marking label. If you are not sure of the type of power supply to your home, consult your product dealer or local power company.

LOCATION — The appliance should be installed in a stable location.

NONUSE PERIODS — The power cord of the appliance should be unplugged from the outlet when left unused for a long period of time.

GROUNDING OR POLARIZATION

- If this product is equipped with a polarized alternating current line plug (a plug having one blade wider than the other), it will fit into the outlet only one way. This is a safety feature. If you are unable to insert the plug fully into the outlet, try reversing the plug. If the plug should still fail to fit, contact your electrician to replace your obsolete outlet. Do not defeat the safety purpose of the polarized plug.

- If this product is equipped with a three-wire grounding type plug, a plug having a third (grounding) pin, it will only fit into a grounding type power outlet. This is a safety feature. If you are unable to insert the plug into the outlet, contact your electrician to replace your obsolete outlet. Do not defeat the safety purpose of the grounding type plug.

POWER-CORD PROTECTION — Power-supply cords should be routed so that they are not likely to be walked on or pinched by items placed upon or against them, paying particular attention to cords at plugs, convenience receptacles, and the point where they exit from the product.

OUTDOOR ANTENNA GROUNDING — If an outside antenna or cable system is connected to the product, be sure the antenna or cable system is grounded so as to provide some protection against voltage surges and built-up static charges. Article 810 of the National Electrical Code, ANSI/NFPA 70, provides information with regard to proper grounding of the mast and supporting structure, grounding of the lead-in wire to an antenna discharge unit, size of grounding conductors, location of antenna-discharge unit, connection to grounding electrodes, and requirements for the grounding electrode. See Figure A.

LIGHTNING — For added protection for this product during a lightning storm, or when it is left unattended and unused for long periods of time, unplug it from the wall outlet and disconnect the antenna or cable system. This will prevent damage to the product due to lightning and power-line surges.

POWER LINES — An outside antenna system should not be located in the vicinity of overhead power lines or other electric light or power circuits, or where it can fall into such power lines or circuits. When installing an outside antenna system, extreme care should be taken to keep from touching such power lines or circuits as contact with them might be fatal.

OVERLOADING — Do not overload wall outlets, extension cords, or integral convenience receptacles as this can result in a risk of fire or electric shock.

OBJECT AND LIQUID ENTRY — Never push objects of any kind into this product through openings as they may touch dangerous voltage points or short-out parts that could result in a fire or electric shock. Never spill liquid of any kind on the product.

SERVICING — Do not attempt to service this product yourself as opening or removing covers may expose you to dangerous voltage or other hazards. Refer all servicing to qualified service personnel.

DAMAGE REQUIRING SERVICE — Unplug this product from the wall outlet and refer servicing to qualified service personnel under the following conditions:

- When the power-supply cord or plug is damaged.
- If liquid has been spilled, or objects have fallen into the product.
- If the product has been exposed to rain or water.
- If the product does not operate normally by following the operating instructions. Adjust only those controls that are covered by the operating instructions as an improper adjustment of other controls may result in damage and will often require extensive work by a qualified technician to restore the product to its normal operation.
- If the product has been dropped or damaged in any way.
- When the product exhibits a distinct change in performance — this indicates a need for service.

REPLACEMENT PARTS — When replacement parts are required, be sure the service technician has used replacement parts specified by the manufacturer or have the same characteristics as the original part. Unauthorized substitutions may result in fire, electric shock, or other hazards.

SAFETY CHECK — Upon completion of any service or repairs to this product, ask the service technician to perform safety checks to determine that the product is in proper operating condition.

WALL OR CEILING MOUNTING — The product should not be mounted to a wall or ceiling.

HEAT — The product should be situated away from heat sources such as radiators, heat registers, stoves, or other products (including amplifiers) that produce heat.

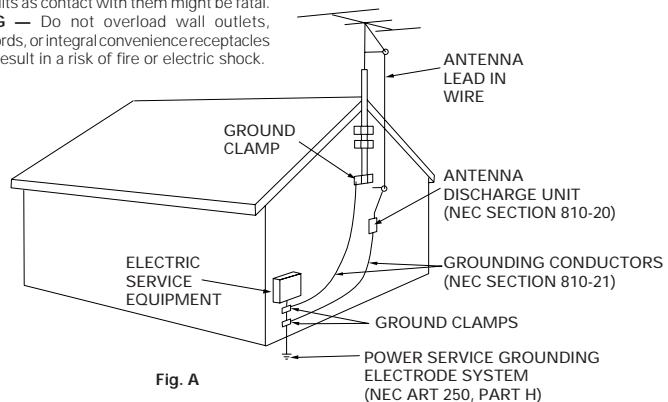

Fig. A

NEC — NATIONAL ELECTRICAL CODE

CAUTION

- Use of controls or adjustments or performance of procedures other than those specified herein may result in hazardous radiation exposure.
- The use of optical instruments with this product will increase eye hazard.

CAUTIONS REGARDING HANDLING

Location

Install the player in a well-ventilated location where it will not be exposed to high temperatures or humidity. Do not install the player in a location which is exposed to direct sunlight, or near stoves or radiators. Excessive heat can adversely affect the cabinet and internal components. Installation of the player in a damp or dusty environment may also result in a malfunction and can be hazardous. Avoid installation near cookers etc., where the player may be exposed to oily smoke, steam or heat.

Installation guidelines

- Placing and using the compact disc player for long periods on heat-generating sources such as amplifiers or near spotlights, etc. will affect product performance. Avoid placing the player on heat-generating sources.
- Install this compact disc player as far as possible away from tuners and TV sets. A compact disc player installed in close proximity to such equipment may cause noise or degradation of the picture.
- Noise may be noticeable when an indoor antenna is used. In such cases, make use of an outdoor antenna or turn off power to the compact disc player.
- When the unit is used in a loud-sound environment, e.g., near a speaker, sound skip may occur. Install the unit away from the speaker or reduce the listening volume.
- Place this unit on a level surface and a stable platform.
- Be sure the player, including its audio and power supply cords, does not touch vibrating materials. Any cause of vibration other than the insulators may cause the disc to skip. Take special care when using the player while it is installed in a carrying case.

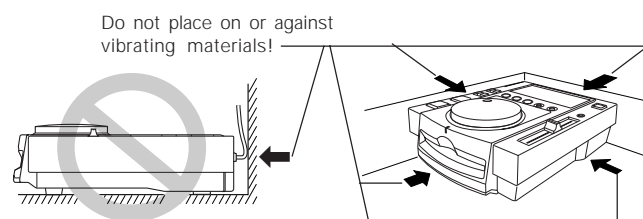

Cleaning the player

To clean the PLAYER wipe with a polishing or a soft, dry cloth. For stubborn dirt, moisten a soft cloth with a weak solution of neutral detergent (diluted in five to six parts water), wring the cloth well, and wipe away the dirt. Use a dry cloth to wipe the surface dry. Do not use volatile liquids such as benzene or thinner which will damage to the unit.

CD lens cleaner

The player's pickup lens should not become dirty in normal use. If for some reason, the lens becomes soiled and malfunctions, contact your nearest PIONEER authorized service center. Lens cleaners for CD players are commercially available, but special care should be exercised in their use as some may cause damage to the lens.

Storing discs

- Discs are made of the same kinds of plastic used for conventional analog audio records. Be careful not to allow discs to warp. Always store discs in their cases vertically, avoiding locations with high heat, humidity, or extremely low temperatures. Avoid leaving discs in cars; the interior of a car in direct sunlight can become extremely hot.
- Always read and abide by the precautionary notes listed on disc labels.

Condensation

When this unit is brought into a warm room from previously cold surroundings or when the room temperature rises sharply, condensation may form inside the unit and impair its performance. In such cases, allow the unit to stand for about an hour or raise the room temperature gradually.

Cleaning and handling compact discs

- The presence of fingerprints or smudges on the surface of the disc will not directly affect the recorded signals, but, depending on the degree of contamination, the brightness of the light reflected from the signal surfaces may be reduced causing degradation of sound quality. Always keep your discs clean by wiping them gently with a soft cloth from the inner edge toward the outer edge.



- If a disc becomes very dirty, dampen a soft cloth with water, (be sure to wring it out well) and wipe the away dirt gently. Remove any water drops with another soft, dry cloth.
- Do not use record cleaning sprays or anti-static agents on discs. Never clean discs with benzene, thinner, or other volatile solvents or damage to the disc surface may result.

- With this player, use only those discs which display the mark shown right (Optical audio digital discs).



- When holding discs, do not touch their signal surfaces. Hold by the edges, or by one edge and the center hole.
- Do not affix gummed labels or tape to the disc surface. Also, do not scratch or damage the label.
- Discs rotate at high speeds inside the player. Do not use damaged, cracked or warped discs.



Do not play a CD with a special shape

Do not play a CD having other shape than a circular disc, such as heart shaped disc. Otherwise malfunction may occur.



FEATURES

This component is a compact disc player designed for use by DJs, combining the functions and operations required for use in disco clubs with the unique features of the CD medium.

DIGITAL JOG BREAK

Built-in Digital Jog Break for Original Sound Creation

Each of three buttons provides a different remix assist function (JET, ZIP, WAH). By selecting the desired function and controlling the jog dial to match the track selection, you can easily create new remix sounds.

JOG DIAL

The large-diameter (100 mm) jog dial allows the user to compensate music beat in the same way common to analog turntables.

Merely rotating the dial with the fingertips allows you to find the precise entry point for tracks, moving in increments of one-frame (1/75th second).

In addition, this jog dial can be used to perform "Super-Fast Search" and "Super-Fast Track Search," which operate faster than the conventional search functions.

TEMPO CONTROL

Long-stroke (100 mm) high-precision slider control allows exact control of track speed.

The digital display with a 0.1% unit readout provides simplified tempo control with higher accuracy (at a variable range of $\pm 10\%$).

● Two Tempo Control Ranges

The maximum adjustable range can be set using two variable ranges or $\pm 10\%$ (in 0.1% steps) and +10 to -16% (0 to +10% in 0.1% steps and 0 to -16% in 0.2% steps) to facilitate adjustment.

QUICK START

Pressing the button from the standby mode produces instantaneous (0.01 second or less) music start.

Normal CD players require up to 0.3 seconds from the standby mode to the production of sound. The quick start function virtually eliminates this time lag making for smoother track-to-track splices.

MASTER TEMPO

Changes music tempo without changing pitch.

With analog systems, changing track speed results in a change in pitch. Master Tempo Control takes advantage of the unique features of digital medium enabling track speed to be changed with no deterioration of the original pitch.

PLAYING ADDRESS

Analog bar graph gives direct indication elapsed and remaining playing time.

This bar graph provides a direct visual readout of the progress of the track playback, comparable to the moving needle position on an analog

record. The length of the bar gives the user immediate knowledge of the current location on the track, and the flashing bar display warns of the impending end of track.

SLOT IN

The new disc loading slot mechanism makes it fast and easy to play, change, and remove discs from the player.

Discs are inserted directly, without the need to open doors or trays, making operation and track selection that much faster.

CUE

Full cueing functions.

● Back Cue Function

Pressing the CUE button after listening to sound from a cue point returns the pickup to the cue point and allows play to restart from there.

The back cue function allows you to return any number of times to a preselected cue point by pressing a single button.

● Auto Cue Function

Automatic bypassing of the non-recorded part of track introductions, cueing the track to a standby point immediately before sound starts.

This function allows instantaneous start of playback when the PLAY button is pressed.

● Cue Point Sampler Function

Allows playing up to one minute of sound from a preselected cue point.

This function is convenient for confirming a cue point or creating a track sampler.

FADER START

Using the DJ Mixer's CROSS FADER slider to perform quick start and back cue.

When the unit is connected to the DJ Mixer DJM-500 or DJM-300 (both sold separately), the mixer's CROSS FADER slider can be operated to perform quick start and back cue.

RELAY PLAY

Connecting two CDJ-100S for Automatic Relay Play

When a track ends on one player, the other player is automatically released from standby mode to begin instant playback.

OIL-DAMPED SUSPENSION

Oil-damped floating suspension protects against vibrations and impacts.

The player has been designed with an oil-damped floating suspension to prevent sound skipping even when the unit is subjected to impacts during use or floor-transmitted vibrations.

FORCED DISC EJECTION

If the eject button does not function or the disc cannot be removed, pushing the pin provided into the forced ejection hole on the front panel will enable the disc to be removed.

When performing forced ejection, be sure to follow the precautions below.

① Be sure to turn OFF the power of the CD player, and check that the disc has stopped rotating. It takes about 30 seconds for the disc to stop rotating after the power has been turned OFF.

If forced ejection is performed while the disc is rotating;

● As the disc will be ejected outside the CD player rotating, it may hit your finger and cause injuries.

● As the disc will be rotating with the clamp unstable, it may be scratched. For the above reasons, never attempt to eject the disc forcibly while it is rotating.

② Always use the pin provided (Do not use other objects). The accessory forced eject pin can be found embedded in the bottom surface of the player.

When the provided forced eject pin is inserted fully into the forced eject hole on the front panel, the loaded disc is ejected about 5-10 mm from the loading slot, making it possible to remove it by hand.

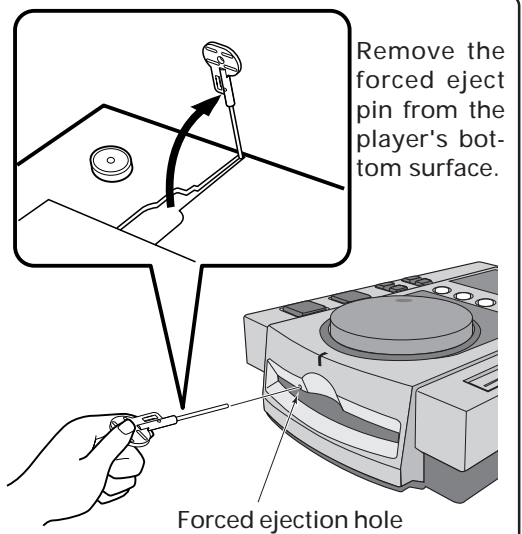

CONNECTIONS

- Before making or changing the connections, switch off the power switch and disconnect the power cord from the AC outlet.
 *See p. 14, "Digital Mode" regarding use of the DIGITAL OUT connector and the DIGITAL OUT switch.

1. AUDIO OUTPUT CONNECTION

Make sure that the white plugs are connected to the left (L) jacks and the red plugs to the right (R) jacks.

A Stereo amplifier connection (without DJ mixer)

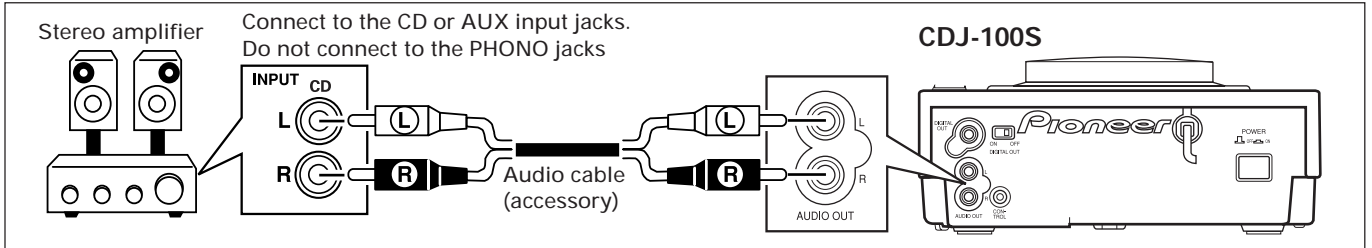

B When using the DJ mixer DJM-300

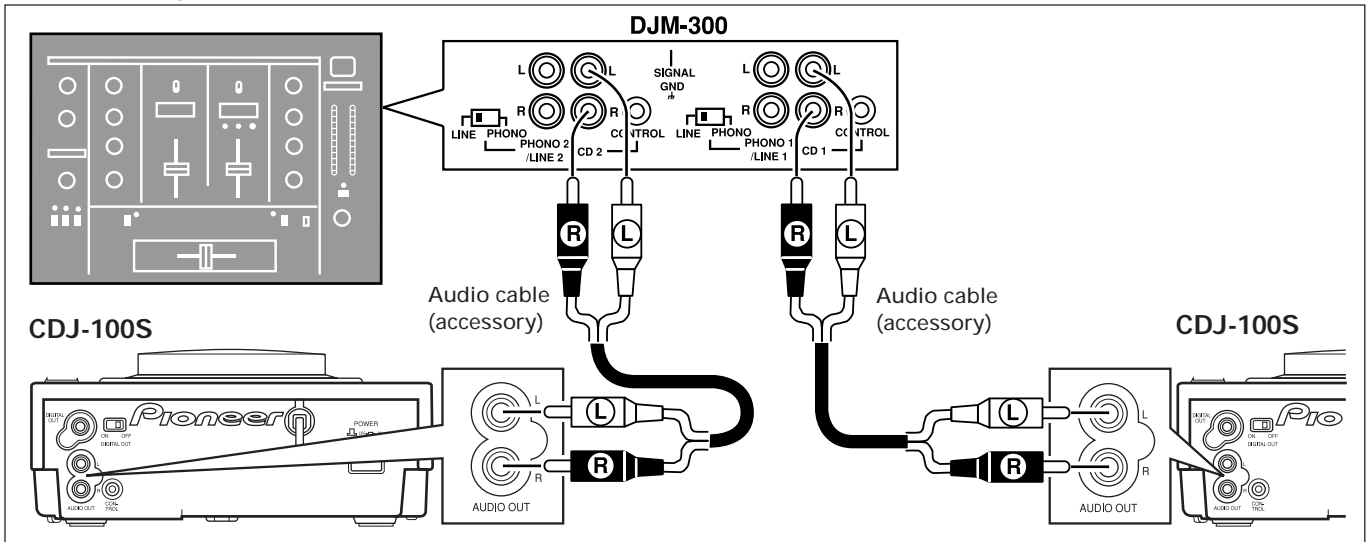

C When using the DJ mixer DJM-500

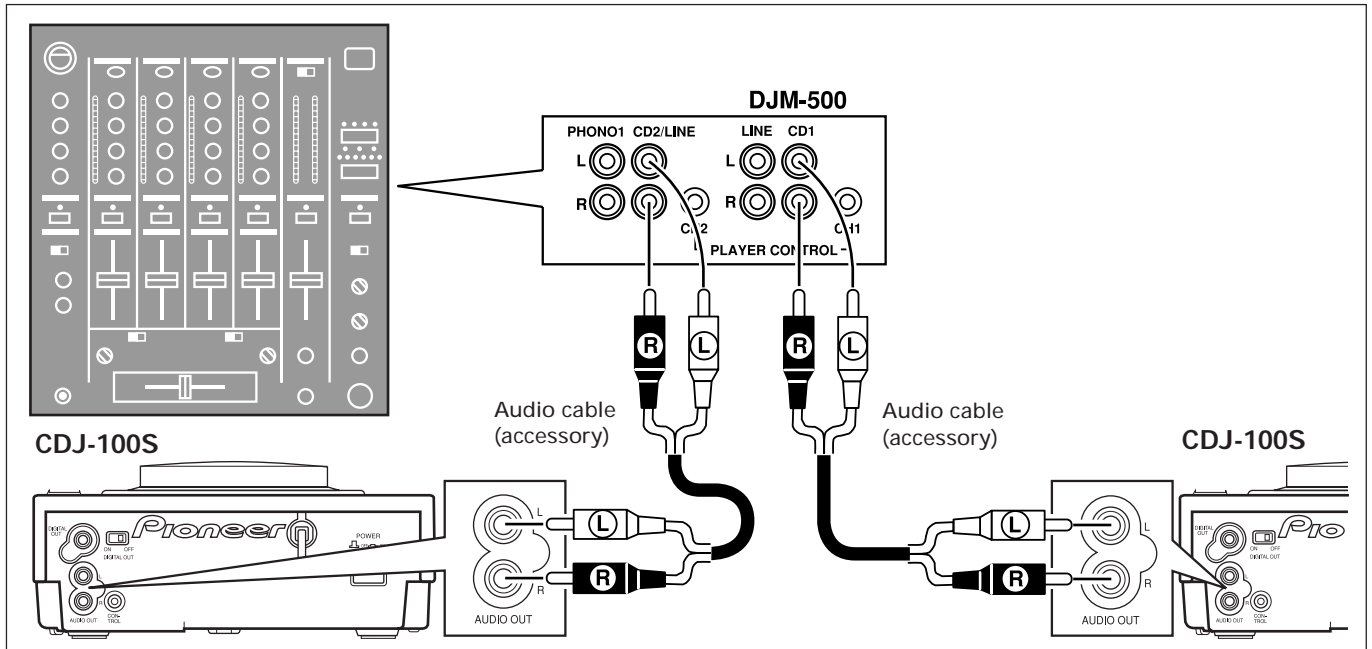

D When using the other DJ mixer

Connect the player's AUDIO OUT jack to the LINE IN or AUX IN jack of a DJ mixer or similar component.

- Do not connect this player to the DJ mixer MIC jacks, as the sound will be distorted and will not be properly reproduced.

BEFORE OPERATIONS: CONNECTIONS

2. CONTROL JACK CONNECTIONS

Use a commercially available mini-plug (dia. 3.5 mm; either stereo or monaural can be used) cable to connect the CONTROL jacks.

By connecting the optional DJM-300 or DJM-500 DJ mixer to the CONTROL jack of this unit, the fader starting or back cueing of this unit can be controlled from the DJ mixer.

When using two players in tandem, connect the CONTROL jacks of the two players. This makes it possible to achieve automatic alternate operation of the two players. For details, see p. 12.

NOTE:

Fader start and relay play cannot be performed simultaneously, since different control cable connections are required.

A Fader starting by DJM-300

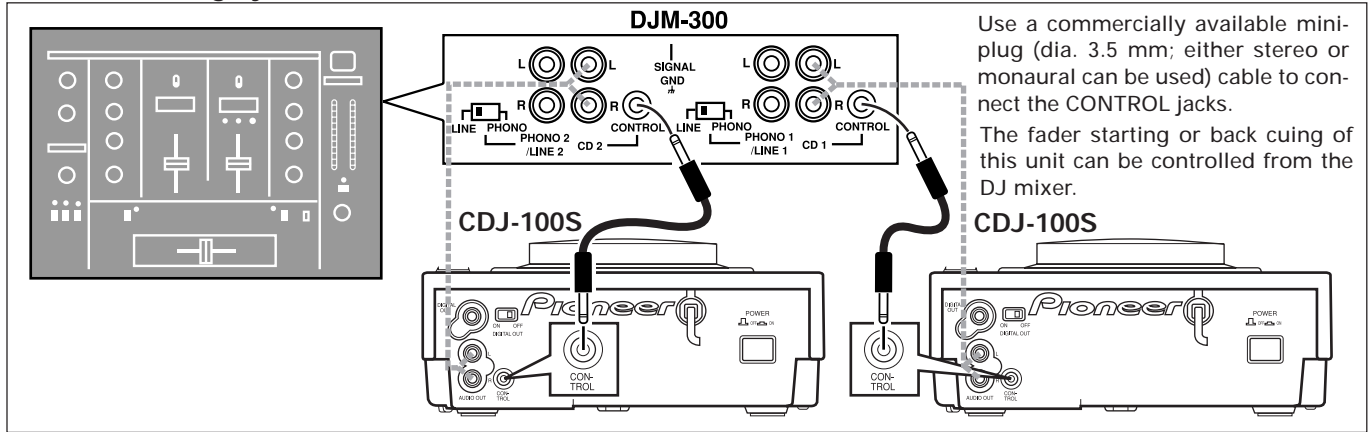

B Fader starting by DJM-500

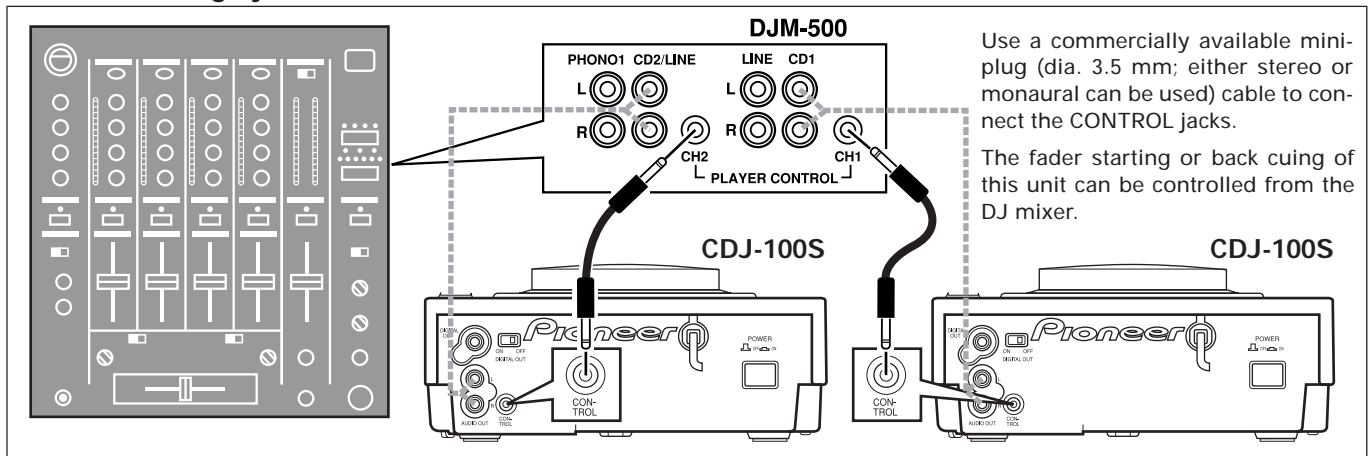

C Relay play using two players

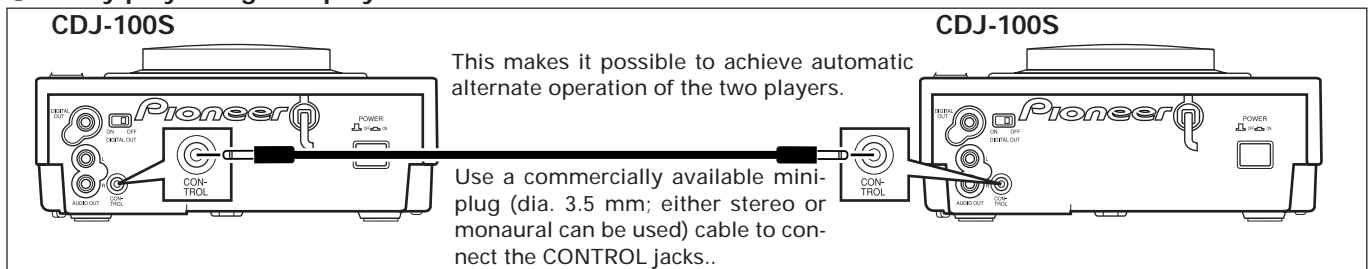

3. POWER CORD CONNECTIONS

After all other connections are made, connect the power cord to a household wall outlet or to the auxiliary AC power takeoff on your amplifier.

- Make sure plugs are fully inserted into the jacks and wall outlet.

NOTE:

If you do the following actions when the disc is spinning in the unit, the unit may malfunction.

- 1) Set the power switch to off, then on.
- 2) Disconnect the power cord, then connect again.

To correct, press the EJECT button to stop the disc. You may then resume player operation.

POWER-CORD CAUTION

Handle the power cord by the plug. Do not pull out the plug by tugging the cord and never touch the power cord when your hands are wet as this could cause a short circuit or electric shock. Do not place the unit, a piece of furniture, etc., on the power cord, or pinch the cord. Never make a knot in the cord or tie it with other cords. The power cords should be routed such that they are not likely to be stepped on. A damaged power cord can cause a fire or give you an electrical shock. Check the power cord once in a while. When you find it damaged, ask your nearest PIONEER authorized service center or your dealer for a replacement.

PANEL FACILITIES

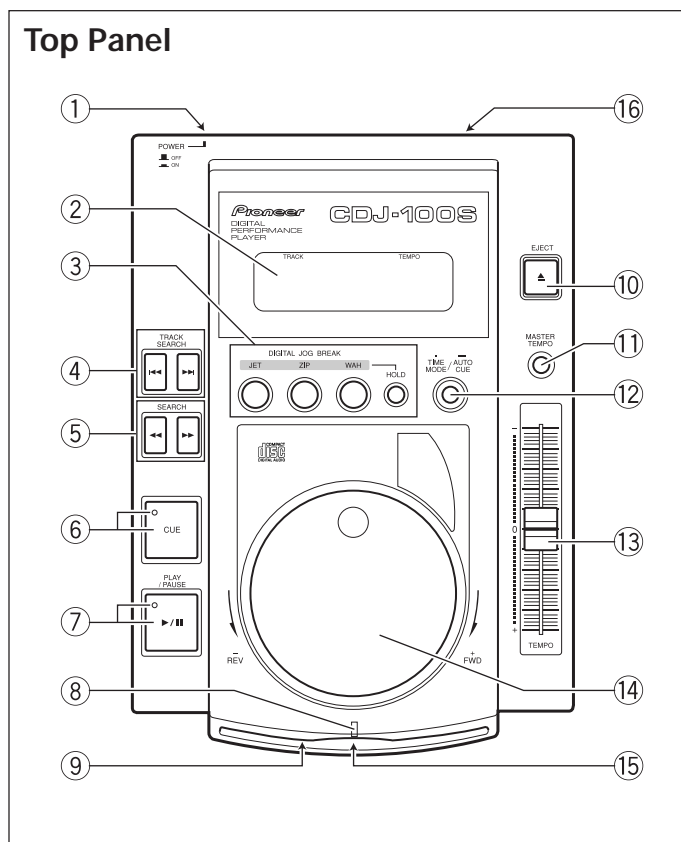

- ① **POWER switch**
(Located on rear panel)
Provides electrical power to the player.
- ② **Display window** ⇒ P. 8
- ③ **DIGITAL JOG BREAK buttons**
(JET, ZIP, WAH, HOLD) ⇒ P. 11
- ④ **TRACK SEARCH buttons** (◀◀, ▶▶) ⇒ P. 9
- ⑤ **SEARCH buttons** (◀◀, ▶▶) ⇒ P. 9, P. 12
- ⑥ **CUE button/indicator**
Three functions are available.
[Setting a Cue Point] ⇒ P. 10
[Back Cue] ⇒ P. 12
[Cue Point Sampler] ⇒ P. 12
[Modify a Cue Point] ⇒ P. 12
- ⑦ **PLAY/PAUSE button/indicator** (▶/||) ⇒ P. 9
- ⑧ **Loading indicator**
Flashes while disc is being loaded or removed through loading slot, and lights steadily when a disc is loaded in the player.
- ⑨ **Force ejection hole** ⇒ P. 4
- ⑩ **EJECT button**
When this button is pressed, disc rotation stops and the disc is ejected from the player's loading slot.

- ⑪ **MASTER TEMPO button** ⇒ P. 11
 - The master tempo function is turned ON/OFF.
 - If the button is held depressed for 2 seconds or more, the tempo adjust dial's variable range is changed ($\pm 10\%$ or $+10\%$ to -16%). When the variable range is changed, the newly selected numerical range is displayed for about 2 seconds (10.0 / 16.0).
 - The variable range is set by default to the ± 10 setting whenever power is first turned on.
- ⑫ **TIME MODE/AUTO CUE button**
Two functions are available.
[Time display]
Each time this button is pressed, the time display changes between the elapsed playback time of the track and the remaining playback time of the track (REMAIN).
 - The REMAIN display appears when power is turned ON.
 [Auto Cue function] ⇒ P. 9
When a disc is initially loaded or when performing track search, this function automatically sets the cue point (the point immediately preceding actual sound output).
 - The Auto Cue function defaults to OFF when power is first turned on.
- ⑬ **TEMPO control knob**
The playback tempo can be changed with this knob. The center clicked position is for normal playback tempo. If you slide the knob (down) towards you (+ side), the music tempo quickens. If the knob is away from you (- side), the music tempo slows.
- ⑭ **Jog dial (+ FWD/- REV)** ⇒ P. 11
- ⑮ **Disc loading slot** ⇒ P. 8
Insert discs with label side up.
 - When playing 8 cm (3-inch) discs, insert the disc in a commercially available CD adapter before loading it in the CD player.
- ⑯ **DIGITAL OUT switch** ⇒ P. 14
(Located on rear panel)

BEFORE OPERATIONS: PANEL FACILITIES

Display Window

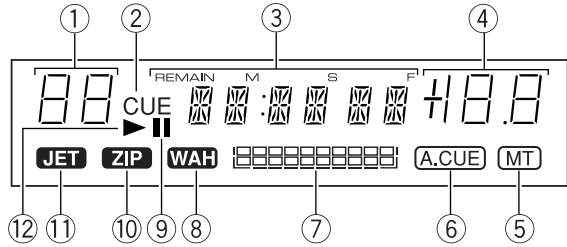

- ① **TRACK number display**
Displays the current number of the track playing.
- ② **CUE indicator**
Flashes when it is possible to input cue point, and lights steadily after the completion of input.
- ③ **Time display (REMAIN)**
The elapsed playback time of the track being played (when the REMAIN indicator is off) or the remaining playback time of the track being played (when the REMAIN indicator is on) is displayed in minutes (M) and seconds (S), or frames (F).
- ④ **Playback tempo display**
Tempo changes made with the TEMPO control knob are performed in 0.1% steps in the ±10% range. 0 to +10% in the +10% to -16% range is indicated in 0.1% steps and 0.2% steps from 0 to -16%.
- ⑤ **MT indicator**
Lights when the MASTER TEMPO function is used.

- ⑥ **A.CUE indicator**
Lights when the AUTO CUE function is used.
- ⑦ **Playback address display**
The elapsed playback time or remaining playback time of the track playing is roughly indicated with the full-scaled bar graph.
 - When no disc is in the disc compartment off
 - When displaying elapsed playback time lights up from the left side
 - When displaying remaining playback time turns off from the left side
 - When remaining playback time is less than 30 seconds blinks
- ⑧ **WAH indicator**
Lights or blinks when WAH function is active. ⇨ P. 11
- ⑨ **Pause indicator (⏸)**
Blinks during pause mode.
- ⑩ **ZIP indicator**
Lights or blinks when ZIP function is active. ⇨ P. 11
- ⑪ **JET indicator**
Lights or blinks when JET function is active. ⇨ P. 11
- ⑫ **Play indicator (▶)**
Lights during playback.

DISC LOADING/UNLOADING

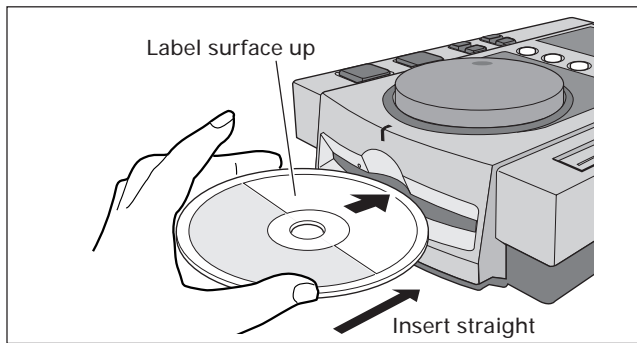

1. Set the rear-panel power switch to ON.

Do not force a disc into the unit when the power switch is set to OFF as this may damage the disc and the unit.

- 2. Insert a disc.**
 - Hold the disc with label surface upwards, and insert into the front panel disc loading slot .
 - When playing an 8 cm (3-inch) disc, place the disc in a commercially available CD adapter before inserting in the loading slot.
 - Only one disc can be loaded at a time. Never attempt to load more than one disc at the same time, or attempt to load a second disc when one disc has already been loaded.
 - When loading a disc, do not placing any twisting force on the disc, or try to force the disc into the slot. Also, do not attempt to interrupt or defeat the motion of the disc when the player begins to draw a disc into the slot or to eject a disc, since damage to the disc or player could occur.

3. Press the EJECT button to remove discs.

- When the EJECT button is pressed, disc rotation stops and the disc is ejected from the loading slot.
- If the disc fails to be ejected when the EJECT button is pressed, the accessory forced eject pin can be inserted into the front-panel's forced eject hole to eject the disc. ⇨ P. 4

CAUTION
Do not attempt to press a disc back into the slot when the EJECT indicator appears. Pressing a disc back into the slot while the EJECT indicator appears may cause the player to stop. In this case, press the EJECT button again and wait until the EJECT indicator goes out before reinserting the disc.

PRECAUTIONS ON PLAYING CD SINGLES (8 cm/3-inch Discs)

- ① When playing CD singles (8 cm/3-inch discs), always use the adapter for 8 cm/3-inch discs. Before loading the disc into the CD player, be sure to check that it is secured properly by the catches of the adapter. If discs have been inserted without the adapter by mistake, remove the disc immediately by pressing the eject button. If the disc does not come out with one press, press another time.
- ② Use 8 cm/3-inch disc adapters labeled with the  mark (recommended standard product). Do not use adapters which cause the disc to idle, nor adapters which are bent or curved.

ORDINARY CD PLAYER OPERATIONS

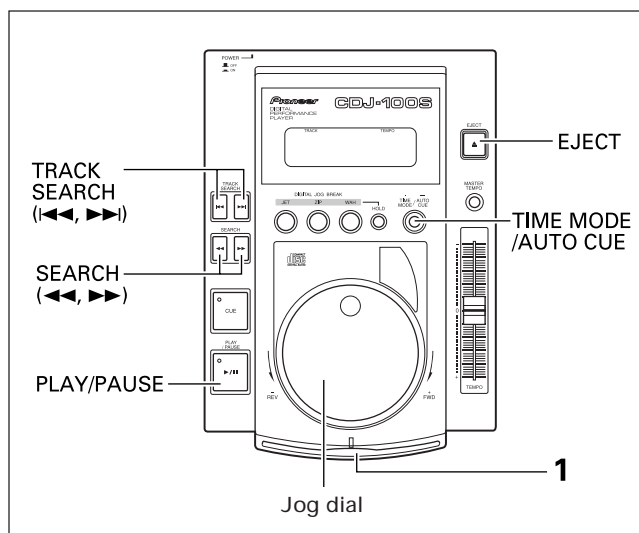

Setting the Auto Cue function ON/OFF

Press and hold the TIME MODE/AUTO CUE button for one or more seconds to toggle the auto cue mode on and off. The auto cue function is turned on when the indicator light showing A.CUE is lit.

Playback Operations

These represent basic playback operations when the auto cue function is off (the display's A.CUE indicator goes off).

1. Insert disc.

- With the disc's label surface upward, insert the disc into the front-panel's disc loading slot.
- When playing an 8 cm/3-inch disc, place the disc in a commercially available CD adapter before inserting in the loading slot.
- Load only one disc at a time.

CAUTION

Do not attempt to press a disc back into the slot when the EJECT indicator appears. Pressing a disc back into the slot while the EJECT indicator appears may cause the player to stop. In this case, press the EJECT button again and wait until the EJECT indicator goes out before reinserting the disc.

2. Play will begin automatically from track 1.

- If the auto-cue function is set to off, playback will not stop after the first track ends but continue sequentially from the first track to the subsequent tracks.
- Play stops automatically after the last track is played.

To Stop Play

Press the EJECT button.

- Play will stop and the disc will be ejected.
- The unit is not provided with a special stop button.

To Pause Play

During playback, press the PLAY/PAUSE button (▶/||).

- The PLAY/PAUSE button's indicator and CUE indicator will flash, and play will be paused.
- When the PLAY/PAUSE button is pressed again, play will resume and the button indicator will light steadily.
- Broken sound will still be audible during the standby mode; if you wish to stop all sound, lower the output sound volume on your audio mixer.
- When the unit has not been operated for 80 minutes or more in pause mode, the disc rotation stops automatically. In this instance, playback can be resumed by pressing the PLAY/PAUSE button.

Track Cueing

■ TRACK SEARCH buttons (◀◀, ▶▶)

Press one of the TRACK SEARCH buttons (◀◀, ▶▶).

- Each time the button is pressed, the track is cued in the direction corresponding to the arrow on the button (during playback of one track, to cue playback to the beginning of the preceding track, press the ◀◀ button twice).
- When the button is pressed down and held, cueing is continuous. If the button is held for two seconds or more, the cue speed increases.
- When the beginning of the first track (track 1) is reached, pressing the ◀◀ button will cue to the last track.
- When the end of the disc's last track is reached, pressing the ▶▶ button will cue to the first track (track 1).

■ Super-Fast Track Search

Rotate the jog dial while pressing one of the TRACK SEARCH buttons (◀◀, ▶▶).

- While holding either one of the buttons depressed, rotate the dial in the direction corresponding to the direction you wish to skip; the unit will enter the high-speed skip mode, with the skip speed corresponding to the amount the dial is ignored.
- The direction of skip is in accordance with the direction in which the jog dial is rotated. (the TRACK SEARCH button direction is released.)
- The high-speed skip mode is canceled when the TRACK SEARCH button is released.

Fast-Forward / Fast-Reverse

■ Operation using the SEARCH buttons

Press the SEARCH buttons (◀◀, ▶▶) during playback. Press and hold the ▶▶ button to fast forward the disc; press and hold the ◀◀ button to do fast reverse.

■ Super-Fast Search

Rotate the jog dial while pressing one of the SEARCH buttons (◀◀, ▶▶)

- Hold down the button while turning the Jog dial in the direction you wish to search to enter fast forward or fast reverse mode.
- The direction of the search is determined by the direction the Jog dial is turned. The direction of the SEARCH button is ignored.
- When you stop turning the Jog dial, the unit returns to playback mode.
- Release the SEARCH button to exit this mode.

DJ PLAYER OPERATIONS

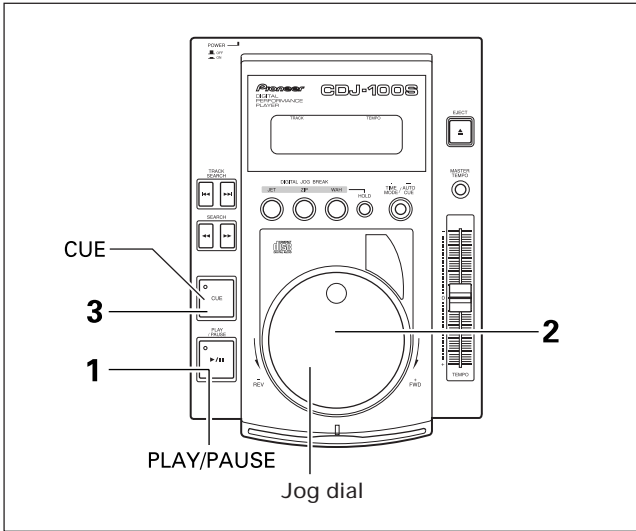
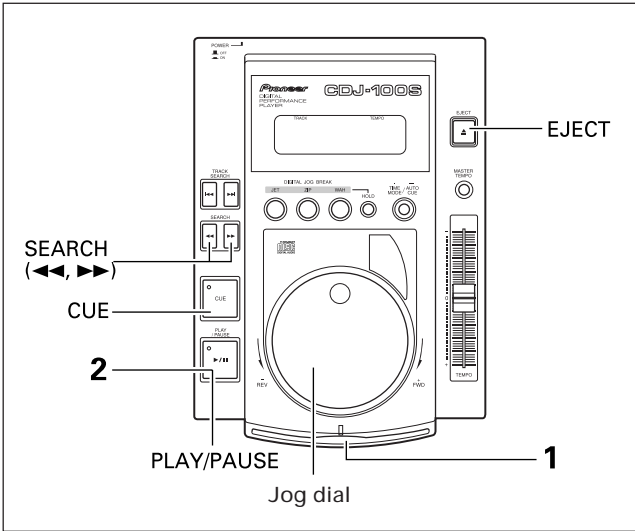

Playback Operations with Auto Cue Function ON

These represent basic playback operations when the auto cue function is on (the display's A.CUE indicator is lit).

1. **Insert disc.**
 - With the disc's label surface upward, insert the disc into the front-panel's disc loading slot.
 - When playing an 8 cm/3-inch disc, place the disc in a commercially available CD adapter before inserting in the loading slot.
 - Load only one disc at a time.

CAUTION
Do not attempt to press a disc back into the slot when the EJECT indicator appears. Pressing a disc back into the slot while the EJECT indicator appears may cause the player to stop. In this case, press the EJECT button again and wait until the EJECT indicator goes out before reinserting the disc.

2. **Press the PLAY/PAUSE button (▶/||).**
 - Press after the CUE button's indicator has lighted. Playback will begin immediately.
 - When playback of one track ends, the player advances to cue the beginning of the next track and enters the standby mode. The CUE indicator lights, and the PLAY/PAUSE button's indicator flashes indicating the unit is in playback standby mode. When the PLAY/PAUSE button (▶/||) is pressed, the cued track will playback immediately.

Cueing by Frames

- **Jog dial**
During playback, press the PLAY/PAUSE button (▶/||) to enter standby mode, then rotate the jog dial to cue by frame (75 frames = 1 second).
 - Cueing is performed in increments of single frames by rotating the jog dial.
 - When the jog dial is rotated clockwise, the player cues forward; rotate counterclockwise to cue in the reverse direction.

Setting a Cue Point

Once a cue point is recorded in the memory, pressing the CUE button causes the unit to enter the playback standby mode at the cue point.

1. **During playback, when the disc comes to the point you wish to cue, press the PLAY/PAUSE button (▶/||) to enter standby mode.**
2. **Rotate the jog dial to search for the desired location.**
 - To set the cue point while listening to the sound, use the jog dial to return the disc to a point just before the point at which you wish to begin playback from the cue. (The cue point is that point immediately after the sound heard in the audible pause mode.)
3. **When the frame number or the audible sound reaches the desired cueing point, press the CUE button.**
 - When the sound is muted and the cue indicator (CUE) lights, the cue point has been stored in memory.
 - Each time a new cue point is stored in memory, any previously stored cue point is erased.

- Cueing is performed at the rate of 48 frames per rotation of the jog dial.
- **Operation using the SEARCH buttons**
With the unit in the standby mode, press one of the SEARCH buttons (◀▶).
 - Each time the button is pressed, the disc will move one frame in the indicated direction.

SPECIAL DISC JOCKEY TECHNIQUES

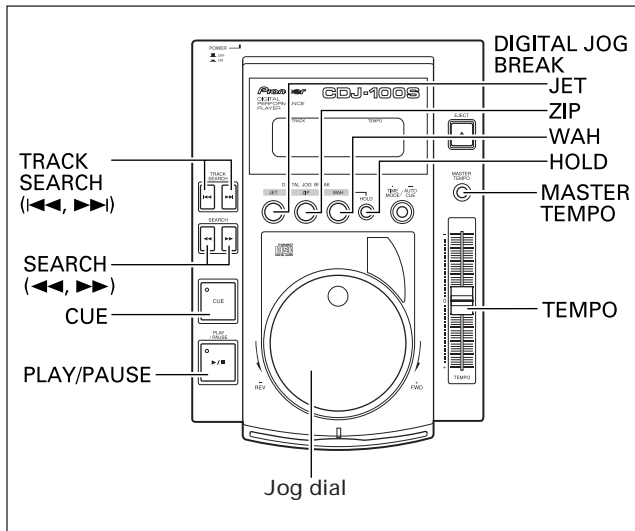

Jog Dial Functions

Playback

During playback, rotate the jog dial slowly

- The beat (tempo) changes in proportion to the amount the dial is rotated, either increasing (FWD+) or decreasing (REV-).
- When dial rotation is stopped, the beat (tempo) returns to its original speed.

Standby (Frame Search)

With the unit in standby mode, rotate the jog dial slowly.

- Frame search will be performed in 1-frame increments.
- If the dial is rotated at a steady rate in the FWD+ direction, playback sound will be audible (normal speed).

During Cue Standby, Press Search Button then Rotate Dial (Cue Point Search).

With the unit in the cue standby mode, if one of the SEARCH buttons (◀, ▶) is pressed, the unit will enter the audible standby mode; if the jog dial is then rotates, various cue points can be searched. Following movement, press the CUE button to set the new cue point.

Rotate the jog dial while holding the TRACK SEARCH button depressed. (Super-Fast Track Search)

While holding the TRACK SEARCH button depressed, rotate the jog dial in the direction in which you wish to perform track search; accelerated high-speed track search will begin in accordance with the direction and amount of rotation.

During playback, rotate the jog dial while holding the SEARCH button depressed. (Super-Fast Search)

Hold down the button while turning the Jog dial in the direction you wish to search to enter fast forward or fast reverse mode.

Master Tempo

1. During playback, press the MASTER TEMPO button.
 - The MT indicator will appear in the display.
2. Move the TEMPO slider to change the playing speed.
 - Even when the music's speed changes, the music pitch does not change.

Using Digital Jog Break

During playback, press one of the DIGITAL JOG BREAK buttons (JET, ZIP, WAH); in the display, the indicator corresponding to the selected effect will flash, and the effect will be applied to the sound in proportion to the amount the jog dial is rotated.

- When the jog dial is released, the sound will gradually return to the original source sound alone.

■ What is JET?

JET means to change the delay time by rotating the jog dial, thus mixing a short delay with the playback sound. Conventional DJ technique has been to use 2 players, starting the same track simultaneously on both players, then introducing a slight delay on one of the players, mixing the two sounds so as to produce the effect of a "jet engine." This function allows you to produce this sound effect easily using a single player.

■ What is ZIP?

The pitch of the playback sound is changed in accordance with the rotation of the jog dial, allowing you to radically change the tonal pitch of the playback sound. When the dial is held rotated in the decreasing direction, a sound can be created virtually indistinguishable from stopping the rotation of an analog record.

■ What is WAH?

When the jog dial is rotated, a filter changing the cutoff frequency is applied to the playback sound, in accordance with the amount the dial is rotated. This allows the DJ to extract and play back desired parts from the playback sound.

Using the HOLD function

Press the HOLD button while the DIGITAL JOG BREAK function is in effect; in the display, the indicator corresponding to the selected effect will switch from flashing to steadily lighted, and the amount of effect currently being applied to the sound will remain steady, even if the jog dial is released.

- When the HOLD function is in effect, the time display will periodically show the HOLD indicator as noted below.

JET + HOLD:	J-HOLD
ZIP + HOLD:	Z-HOLD
WAH + HOLD:	W-HOLD

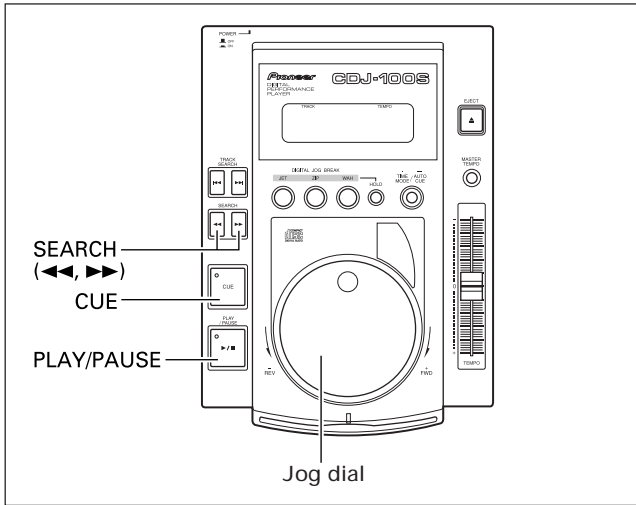

Cueing

- **Confirm a cue point (cue point sampler)**
After setting a cue point, press and hold the CUE button.
 - As long as the CUE button is held depressed, the sound of the track at the cued point can be heard.
- **Return to a cue point (back cue)**
 1. **During playback, press the CUE button.**
 - The player returns to the set cue point and enters standby mode.
 2. **Press the PLAY/PAUSE button (▶/||).**
 - Playback will begin instantly from the cue point.
- **Modify a cue point (cue point adjust)**
 1. **During playback, press the CUE button.**
 - The player returns to the set cue point and enters standby mode.
 2. **Press the SEARCH buttons (◀◀, ▶▶).**
 - The cue point moves in 1-frame increments (broken sound will be reversed).
 - The cue point can also be changed by rotating the jog dial after pressing the SEARCH buttons (◀◀, ▶▶).
 3. **Press the CUE button.**
 - The new cue point will be set at the point the CUE button is pressed.

Fader Start Playback

A commercially available mini-plug cord can be used to connect this unit's CONTROL jack to one of the optional DJ mixers DJM-500 or DJM-300; when this is done, the player's CUE standby is automatically released when the DJ mixer's channel fader is raised, thus allowing instant playback start. The player's fader start operation can also be used to produce cross-fader effects. Restoring the fader position returns the player to its cue point (back cue) automatically.

The following operations are performed on the DJ Mixer. For details regarding connections and operation, consult the Operating Instructions furnished with your DJ Mixer.

- ① Set CROSS FADER switch to ON.
- ② Set FADER START switch to ON.

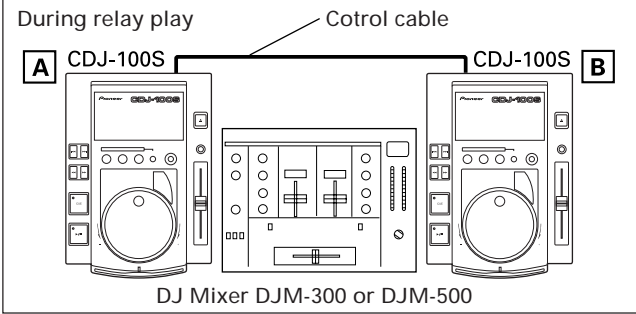
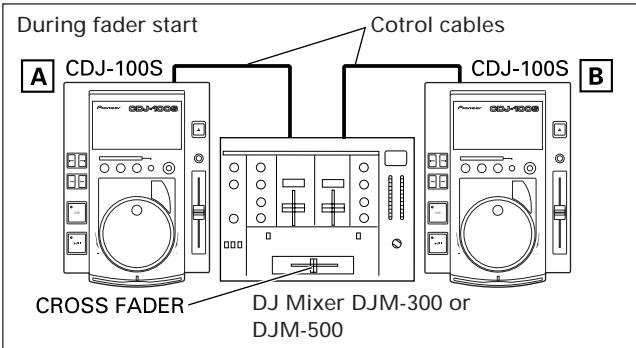

- ③ When "A" is in standby mode at cue point, move the CROSS FADER slider from right to left to automatically start playback on "A".
- ④ When "B" is in standby mode at cue point, move the CROSS FADER slider from left to right to automatically start playback on "B". ("A" will simultaneously be back-cued (returns to cue point)).

NOTE:
Fader start and relay play cannot be performed simultaneously, since different control cable connections are required.

Relay Play Using Two Players

Relay play can be performed by using a commercially available miniplug cord to connect the CONTROL jacks of this unit and another CDJ series CD player.

- Set both player's auto cue function to ON (the AUTO CUE indicators will light in the displays).
 - Set your audio mixer's fader control to its center position.
1. **Begin playback on the first player.**
 2. **When the currently playing track ends, playback will begin automatically on the standby player.**
 3. **The first player will enter cue standby mode at the beginning of the next track on its disc.**
 - By repeating this operation, the two players can be used to perform continuous relay play.
 - By loading new discs on the standby player, you can construct a continuous program of whatever tracks you wish.
 - By setting a cue point on the standby player, you can perform relay to any desired cue point on the selected track (see page 10: Setting a Cue Point).

NOTE:

- Relay play may not operate properly if the audio out jacks on the two players are not connected to the same audio mixer.
- If the power to one player is turned off during its playback, the other player may begin playback.

MIXING DIFFERENT TRACKS

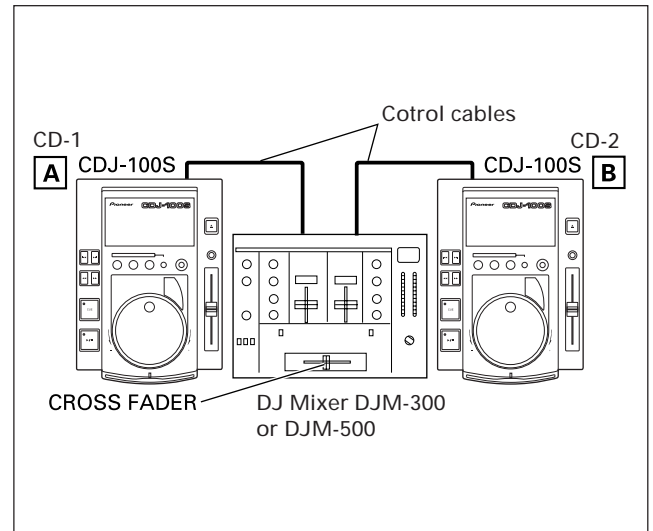
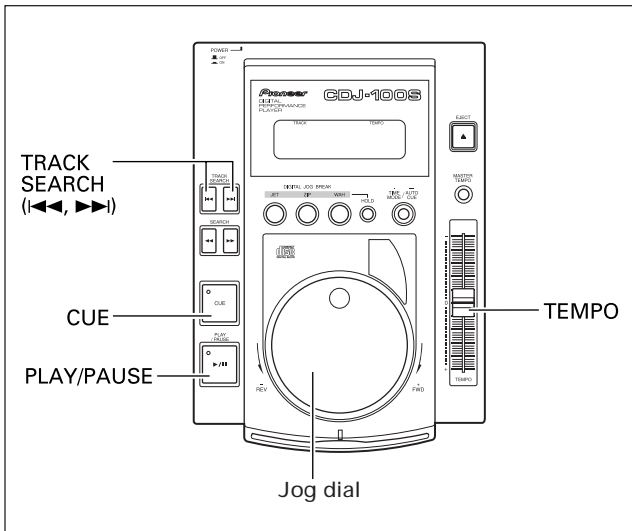

(Example: Mix track B with currently playing track A from the main speakers.)

- Connect CD-1 to the DJ mixer's CH 1, and connect CD-2 to CH 2.
 - Raise the TRIM, CHANNEL FADER, and MASTER LEVEL settings appropriately so that sound is produced from CD-1.
1. Set the DJ Mixer's CROSS FADER slider at its left side (CH 1).
 - Track A is heard from speakers.
 2. Load a CD on player CD-2.
 3. Press the TRACK SEARCH buttons (◀◀, ▶▶) on player CD-2 to find and select track B.
 4. Set the Mixer's MONITOR SELECTOR button CH 2 to ON.
 5. Rotate the DJ Mixer's MONITOR LEVEL so that track B can be heard from the headphones.
 - Only track A is heard from the main speakers.
 6. Set cueing for track B on the headphones.
 - ① With player CD-2 in the playback mode, press the PLAY/PAUSE button (▶/||) hear the point you wish to cue.
 - The player will enter the pause mode (Broken sound will be audible).
 - ② Rotate player CD-2's jog dial and search for the track's cue point (first beat).
 - ③ When you have settled on the cue point, press the CUE button on player CD-2.
 - The player's sound will be muted and cueing will be completed.
 7. Simultaneously press player CD-2's PLAY/PAUSE button (▶/||) when track A is heard from the speakers.
 - Only the track A will be heard from the main speakers.
 - Track B will be heard from the headphones.

8. Move the TEMPO slider to match the tempo (BPM=beats per minute) of tracks A and B.
 - ① The DJ mixer displays the track's BPM (in numbers).
 - For details regarding the operation of the DJ Mixer, consult the Operating Instructions accompanying the DJ Mixer.
 - ② Move the TEMPO slider of player CD-2 so that the BPM of track B match those of track A.
 - When the two BPM rates match, the BPM synchronization is complete.
 9. Press the CUE button on player CD-2.
 - Player CD-2 will enter standby mode at the cueing point.
 10. As soon as track A is heard from the speakers, press the PLAY/PAUSE button (▶/||) on player CD-2.
 - Track B begins playing.
 11. While checking the sound on the headphones, gradually move the DJ Mixer's CROSS FADER slider from left to right.
 - The sound of track A from the speakers will steadily become mixed with the sound of track B.
 - When the DJ Mixer's CROSS FADER slider has moved all the way to the right side, the sound heard from the speaker will have changed from track A to track B, and the operation is complete.
- **Long Mix Play**
If the BPM rates match, mixing of tracks A and B will sound good even if the CROSS FADER slider is in the middle position.
 - **Fader Start Play**
Using the cross fader start function of the DJ Mixer DJM-500 or DJM-300, step 10 above can be eliminated for even simpler mixing. In addition, when the CROSS FADER slider is returned to its original position, the status returns to that in step 9 (player CD-2 at its cue point), so that you can repeat the same play as many times as you like.

DIGITAL MODE

This unit is designed to allow digital output when the rear panel's DIGITAL OUT switch is set to ON. The following button functions, however, will not operate in the DIGITAL OUT mode: CUE, DIGITAL JOG BREAK (JET, ZIP, WAH, HOLD), MASTER TEMPO. In the event that such non-functioning keys are pressed, the display will show D-OUT ON. Even if these functions are currently operating, they will be non-functional when the Digital Out switch is set to ON. (Cue Point memory alone will continue to be effective after Digital Out is reset to OFF.) In addition, other control functions, such as relay play and fader start will also not function when Digital Out is set to ON, and Auto Cue will enter pause at the start of the playback track. Any FL frames current displayed will be erased. In normal mode, when the Play/Pause button is pressed during playback, the frame's interrupted sound will be output, but when the same operation is attempted in the digital out mode, the frame's interrupted sound will not be output (during pause, no sound is output). Also, after a cue point is memorized in normal mode, if the DIGITAL OUT switch is set to ON, the analog output will be somewhat delayed from the digital output.

Precautions Regarding Connections

- When connecting a cable to the DIGITAL OUT jack, be sure the power is turned off both to this unit and to the other unit (DAT, amplifier, etc.).
- Be sure that the other component's gain and volume control dials are set to their lowest settings before switching this unit's DIGITAL OUT switch to ON.

Connection Examples

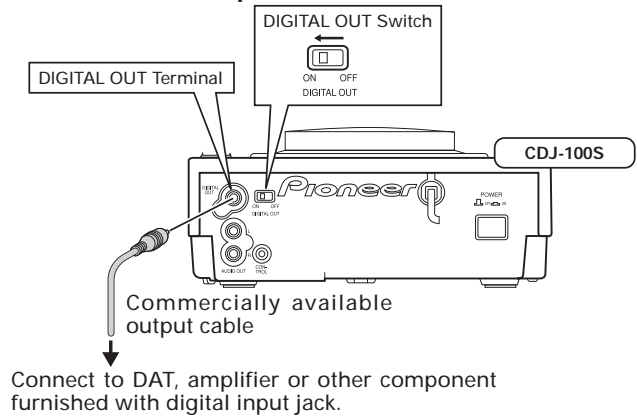

TROUBLESHOOTING

Incorrect operations can be mistaken as malfunctions. If you believe the unit is not operating correctly, consult the chart below. Sometimes incorrect operation may be due to a malfunction in another component. If the problem is not fixed, check the other components used with the player. If the problem still persists, contact your nearest Pioneer authorized service center or dealer for service.

Symptom	Cause	Remedy
Disc doesn't eject even when EJECT button is pressed.	<ul style="list-style-type: none"> ● Power plug is disconnected from outlet. ● EJECT button is not operating. 	<ul style="list-style-type: none"> ● Connect plug to wall outlet. ● Use Forced eject pin to remove disc. (See page 4)
Playback immediately stops when started. During playback, the player pauses or stops.	<ul style="list-style-type: none"> ● Disc is loaded upside down. ● Smudges on the disc, etc. 	<ul style="list-style-type: none"> ● Load the disc correctly with the label side UP. ● Clean the smudges from the disc and then play it again.
No sound is audible.	<ul style="list-style-type: none"> ● Output cables are connected incorrectly or are loose. ● Incorrect operation of audio mixer. ● Pin plugs and/or amplifier terminals are dirty. ● Player is in pause mode. 	<ul style="list-style-type: none"> ● Recheck connections. Refer to installation instructions. ● Check the settings of the audio mixer switches and sound volume controls. ● Clean away dirt. ● Press the PLAY/PAUSE button.
Sound is distorted, noise is output.	<ul style="list-style-type: none"> ● Incorrect connections. ● Pin plugs and/or amplifier terminals are dirty. ● Interference is being picked up from a TV set. 	<ul style="list-style-type: none"> ● Connect to audio mixer's LINE INPUT terminals. (Do not connect to MIC terminals.) ● Clean away dirt. ● Switch OFF TV set, move player away from TV set or plug the player into a separate outlet.
With certain discs, loud noise is produced or play stops.	<ul style="list-style-type: none"> ● Disc has a bad scratch or warp. ● Disc is extremely dirty. 	<ul style="list-style-type: none"> ● Replace disc. ● Clean disc.

Symptom	Cause	Remedy
When the auto cue function is set ON, track search is not finished.	<ul style="list-style-type: none"> ● If the sound muted portion between selections is long, searching time will be long. ● If the sound muted portion is recorded for about 20 seconds or more, playback will start without the auto cue function. 	<ul style="list-style-type: none"> ● Press TIME MODE/AUTO CUE button for more than 1 second to set the auto cue function OFF.
Back cue function cannot be carried out even though the CUE button is pressed in playback mode.	<ul style="list-style-type: none"> ● The cue point is not set yet. 	<ul style="list-style-type: none"> ● Set the cue point. (See page 10.)
DJ mode doesn't work.	<ul style="list-style-type: none"> ● DIGITAL OUT switch is set to ON (digital output is effective). 	<ul style="list-style-type: none"> ● Set DIGITAL OUT switch to OFF.
The picture of the TV screen is fluctuated or FM broadcast is interfered with noise.	<ul style="list-style-type: none"> ● Interference is being picked up from the CD player. 	<ul style="list-style-type: none"> ● Turn off POWER of the player, or move the player away from the TV or tuner.
The disc is not rotating when power is ON.	<ul style="list-style-type: none"> ● The disc rotation stops automatically if no operation has been performed for 80 minutes or more in pause mode. 	<ul style="list-style-type: none"> ● Playback can be started by pressing the PLAY/PAUSE button. Press the EJECT button to eject the disc.

- Static electricity and other external effects may cause this unit to malfunction. In this case, set the power switch to OFF, then switch it on again after the disc has come to a complete stop.
- This unit cannot playback non-finalized CD-R discs (partial discs).
- This component is designed to play both ordinary 12 cm (5-inch) discs and 8 cm (3-inch) discs mounted on adapters. Non-round (eccentrically shaped discs) cannot be played, since damage or malfunction may result.

Error display

When the player detects an error during operation, it will immediately stop and display an error code in the display window. Check the error code with those listed in the table below to determine the cause of error. Contact your nearest Pioneer authorized service center if the cause of the error is unknown, too difficult to fix or if the same error code continues to display after the remedy has been tried. Refer to the error code when speaking to the Pioneer service representative.

Displayed error code number	Type of error	Error contents	Possible Cause → Remedy
E-72 01	TOC READ ERROR	TOC data cannot be read after 20 seconds.	Disc has scratch → Replace disc Disc is dirty → Clean disc
E-72 02	FG PULSE ERROR	Disc is rotating, but rotation cannot be ascertained.	
E-83 01	PLAYER ERROR	Disc loaded cannot be played properly.	
E-83 02	PLAYER ERROR	Disc loaded cannot be played properly.	Foreign object is in disc compartment slot. → Remove it.
E-91 01	MECHANICAL TIME OUT	Mechanical operation did not end in allotted time.	
E-91 03	MECHANICAL TIME OUT	Mechanical operation did not end in allotted time.	

Should this product require service in the U.S.A. and you wish to locate the nearest Pioneer Authorized Independent Service Company, or if you wish to purchase replacement parts, operating instructions, service manuals, or accessories, please call the number shown below.

800 – 872 – 4159

Please do not ship your product to Pioneer without first calling the Customer Service Department at the above listed number for assistance.

**PIONEER ELECTRONICS SERVICE, INC.
CUSTOMER SUPPORT DIVISION
P.O. BOX 1760, LONG BEACH,
CA 90801-1760, U.S.A.**

For warranty information please see the Limited Warranty sheet included with your product.

Should this product require service in Canada, please contact a Pioneer Canadian Authorized Dealer to locate the nearest Pioneer Authorized Service Company in Canada. Alternatively, please contact the Customer Service Department at the following address:

Pioneer Electronics of Canada, Inc.

**300 Allstate Parkway
Markham, ON L3R 0P2
(905) 479-4411**

For warranty information please see the Limited Warranty sheet included with your product.

SPECIFICATIONS

1. General

System Compact disc digital audio system
 Power requirements AC 120 V, 60 Hz
 Power consumption 12 W
 Operating temperature +5°C – +35°C (+41°F – +95°F)
 Operating humidity 5% – 85%
 (There should be no condensation of moisture.)
 Weight 2.2 kg (4 lbs 14 oz)
 Dimensions 217.7 (W) × 310.7 (D) × 94.5 (H) mm
 8-9/16 (W) × 12-1/4 (D) × 3-3/4 (H) in.

2. Audio section

Frequency response 4 Hz – 20 kHz (EIAJ)
 Signal-to-noise ratio 96 dB or more (EIAJ)
 Output level 2.0 V
 Channels 2-channel (stereo)

3. Accessories

- Operating instructions 1
- Audio cable 1
- Limited warranty 1

NOTE:
 Specifications and design are subject to possible modification without notice.

Maintenance:

We recommend regular maintenance to ensure the safe and proper function of this unit. Extended service life can be expected if the unit maintained properly.



Dear Customer:

Selecting fine audio equipment such as the unit you've just purchased is only the start of your musical enjoyment. Now it's time to consider how you can maximize the fun and excitement your equipment offers. This manufacturer and the Electronic Industries Association's Consumer Electronics Group want you to get the most out of your equipment by playing it at a safe level. One that lets the sound come through loud and clear without annoying blaring or distortion-and, most importantly, without affecting your sensitive hearing.

Sound can be deceiving. Over time your hearing "comfort level" adapts to higher volumes of sound. So what sounds "normal" can actually be loud and harmful to your hearing. Guard against this by setting your equipment at a safe level BEFORE your hearing adapts.

To establish a safe level:

- Start your volume control at a low setting.
- Slowly increase the sound until you can hear it comfortably and clearly, and without distortion.

Once you have established a comfortable sound level:

- Set the dial and leave it there.

Taking a minute to do this now will help to prevent hearing damage or loss in the future. After all, we want you listening for a lifetime.

We Want You Listening For A Lifetime

Used wisely, your new sound equipment will provide a lifetime of fun and enjoyment. Since hearing damage from loud noise is often undetectable until it is too late, this manufacturer and the Electronic Industries Association's Consumer Electronics Group recommend you avoid prolonged exposure to excessive noise. This list of sound levels is included for your protection.

Decibel

Level	Example
30	Quiet library, soft whispers
40	Living room, refrigerator, bedroom away from traffic
50	Light traffic, normal conversation, quiet office
60	Air conditioner at 20 feet, sewing machine
70	Vacuum cleaner, hair dryer, noisy restaurant
80	Average city traffic, garbage disposals, alarm clock at two feet.

THE FOLLOWING NOISES CAN BE DANGEROUS UNDER CONSTANT EXPOSURE

90	Subway, motorcycle, truck traffic, lawn mower
100	Garbage truck, chain saw, pneumatic drill
120	Rock band concert in front of speakers, thunderclap
140	Gunshot blast, jet plane
180	Rocket launching pad

Information courtesy of the Deafness Research Foundation.



Published by Pioneer Electronic Corporation.
 Copyright © 1998 Pioneer Electronic Corporation.
 All rights reserved.